

PM200DSA120

FLAT-BASE TYPE
INSULATED PACKAGE

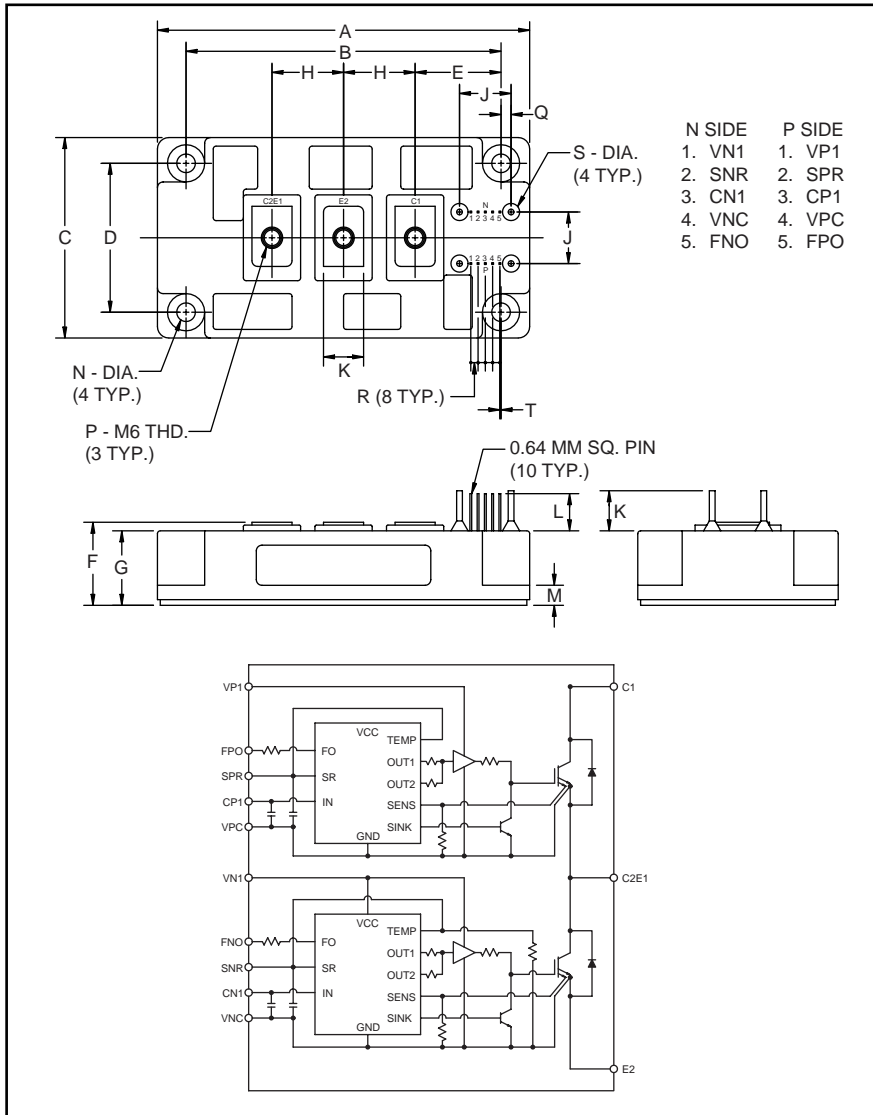

Description:

Mitsubishi Intelligent Power Modules are isolated base modules designed for power switching applications operating at frequencies to 20kHz. Built-in control circuits provide optimum gate drive and protection for the IGBT and free-wheel diode power devices.

Features:

- Complete Output Power Circuit
- Gate Drive Circuit
- Protection Logic
 - Short Circuit
 - Over Current
 - Over Temperature
 - Under Voltage

Applications:

- Inverters
- UPS
- Motion/Servo Control
- Power Supplies

Ordering Information:

Example: Select the complete part number from the table below -i.e. PM200DSA120 is a 1200V, 200 Ampere Intelligent Power Module.

Type	Current Rating Amperes	V _{CES} Volts (x 10)
PM	200	120

Outline Drawing and Circuit Diagram

Dimensions	Inches	Millimeters
A	5.12	130.0
B	4.33±0.010	110.0±0.25
C	2.76	70.0
D	2.05±0.010	52.0±0.25
E	1.18	30.0
F	1.14 +0.04/-0.02	29.0 +1/-0.5
G	1.02	26.0
H	0.98	25.0
J	0.71	18.0

Dimensions	Inches	Millimeters
K	0.55	14.0
L	0.51	13.0
M	0.28	7.0
N	0.26 Dia.	Dia. 6.5
P	M6 Metric	M6
Q	0.14	3.5
R	0.100	2.54
S	0.08 Dia.	Dia. 2.0
T	0.016	0.42

PM200DSA120FLAT-BASE TYPE
INSULATED PACKAGE**Absolute Maximum Ratings, $T_j = 25^\circ\text{C}$ unless otherwise specified**

	Symbol	Ratings	Units
Power Device Junction Temperature	T_j	-20 to 150	$^\circ\text{C}$
Storage Temperature	T_{stg}	-40 to 125	$^\circ\text{C}$
Case Operating Temperature	T_C	-20 to 100	$^\circ\text{C}$
Mounting Torque, M6 Mounting Screws	—	3.92~5.88	N · m
Mounting Torque, M6 Main Terminal Screws	—	3.92~5.88	N · m
Module Weight (Typical)	—	630	Grams
Supply Voltage Protected by OC and SC ($V_D = 13.5 - 16.5\text{V}$, Inverter Part)	$V_{\text{CC(prot.)}}$	800	Volts
Isolation Voltage (Main Terminal to Baseplate, AC 1 min.)	V_{iso}	2500	Vrms

Control Sector

Supply Voltage (Applied between $V_{P1}-V_{PC}$, $V_{N1}-V_{NC}$)	V_D	20	Volts
Input Voltage (Applied between $C_{P1}-V_{PC}$, $C_{N1}-V_{NC}$)	V_{CIN}	10	Volts
Fault Output Supply Voltage (Applied between $F_{PO}-V_{PC}$ and $F_{NO}-V_{NC}$)	V_{FO}	20	Volts
Fault Output Current (Sink Current at F_{PO} , F_{NO} Terminal)	I_{FO}	20	mA

IGBT Inverter Sector

Collector-Emitter Voltage ($V_D = 15\text{V}$, $V_{\text{CIN}} = 5\text{V}$)	V_{CES}	1200	Volts
Collector Current, ($T_C = 25^\circ\text{C}$)	I_C	200	Amperes
Peak Collector Current, ($T_C = 25^\circ\text{C}$)	I_{CP}	400	Amperes
Supply Voltage (Applied between C1 - E2)	V_{CC}	900	Volts
Supply Voltage, Surge (Applied between C1 - E2)	$V_{\text{CC(surge)}}$	1000	Volts
Collector Dissipation	P_C	1140	Watts

Electrical and Mechanical Characteristics, $T_j = 25^\circ\text{C}$ unless otherwise specified

Characteristics	Symbol	Test Conditions	Min.	Typ.	Max.	Units
Control Sector						
Over Current Trip Level Inverter Part	OC	$-20^\circ\text{C} \leq T \leq 125^\circ\text{C}$, $V_D = 15\text{V}$	240	360	—	Amperes
Short Circuit Trip Level Inverter Part	SC	$-20^\circ\text{C} \leq T \leq 125^\circ\text{C}$, $V_D = 15\text{V}$	320	540	—	Amperes
Over Current Delay Time	$t_{\text{off}}(\text{OC})$	$V_D = 15\text{V}$	—	5	—	μs
Over Temperature Protection	OT	Trip Level	100	110	120	$^\circ\text{C}$
	OT_r	Reset Level	85	95	105	$^\circ\text{C}$
Supply Circuit Under Voltage Protection	UV	Trip Level	11.5	12.0	12.5	Volts
	UV_r	Reset Level	—	12.5	—	Volts
Supply Voltage	V_D	Applied between V_{P1} - V_{PC} , V_{N1} - V_{NC}	13.5	15	16.5	Volts
Circuit Current	I_D	$V_D = 15\text{V}$, $V_{\text{CIN}} = 5\text{V}$, V_{N1} - V_{NC}	—	23	30	mA
		$V_D = 15\text{V}$, $V_{\text{CIN}} = 5\text{V}$, V_{XP1} - V_{XPC}	—	23	30	mA
Input ON Threshold Voltage	$V_{\text{th(on)}}$	Applied between	1.2	1.5	1.8	Volts
Input OFF Threshold Voltage	$V_{\text{th(off)}}$	C_{P1} - V_{PC} , C_{N1} - V_{NC}	1.7	2.0	2.3	Volts
PWM Input Frequency	f_{PWM}	3- ϕ Sinusoidal	—	15	20	kHz
Fault Output Current	$I_{\text{FO(H)}}$	$V_D = 15\text{V}$, $V_{\text{FO}} = 15\text{V}$	—	—	0.01	mA
	$I_{\text{FO(L)}}$	$V_D = 15\text{V}$, $V_{\text{FO}} = 15\text{V}$	—	10	15	mA
Minimum Fault Output Pulse Width	t_{FO}	$V_D = 15\text{V}$	1.0	1.8	—	ms
SXR Terminal Output Voltage	V_{SXR}	$T_j \leq 125^\circ\text{C}$, $R_{\text{in}} = 6.8 \text{ k}\Omega$ (S_{PR} , S_{NR})	4.5	5.1	5.6	Volts

Electrical and Mechanical Characteristics, $T_j = 25^\circ\text{C}$ unless otherwise specified

Characteristics	Symbol	Test Conditions	Min.	Typ.	Max.	Units
IGBT Inverter Sector						
Collector Cutoff Current	I_{CES}	$V_{CE} = V_{CES}, T_j = 25^\circ\text{C}$	—	—	1	mA
		$V_{CE} = V_{CES}, T_j = 125^\circ\text{C}$	—	—	10	mA
Emitter-Collector Voltage	V_{EC}	$-I_C = 200\text{A}, V_D = 15\text{V}, V_{CIN} = 5\text{V}$	—	2.5	3.5	Volts
Collector-Emitter Saturation Voltage	$V_{CE(sat)}$	$V_D = 15\text{V}, V_{CIN} = 0\text{V}, I_C = 200\text{A}$	—	2.3	3.2	Volts
		$V_D = 15\text{V}, V_{CIN} = 0\text{V}, I_C = 200\text{A}, T_j = 125^\circ\text{C}$	—	2.1	2.9	Volts
Inductive Load Switching Times	t_{on}		0.5	1.4	2.5	μs
	t_{rr}	$V_D = 15\text{V}, V_{CIN} = 0 \leftrightarrow 5\text{V}$	—	0.2	0.4	μs
	$t_{C(on)}$	$V_{CC} = 600\text{V}, I_C = 200\text{A}$	—	0.4	1.0	μs
	t_{off}	$T_j = 125^\circ\text{C}$	—	2.0	3.5	μs
	$t_{C(off)}$		—	0.6	1.1	μs

Thermal Characteristics

Characteristic	Symbol	Condition	Min.	Typ.	Max.	Units
Junction to Case Thermal Resistance	$R_{th(j-c)Q}$	Each IGBT	—	—	0.11	$^\circ\text{C/Watt}$
	$R_{th(j-c)F}$	Each FWDi	—	—	0.18	$^\circ\text{C/Watt}$
Contact Thermal Resistance	$R_{th(c-f)}$	Case to Fin Per Module, Thermal Grease Applied	—	—	0.038	$^\circ\text{C/Watt}$

Recommended Conditions for Use

Characteristic	Symbol	Condition	Value	Units
Supply Voltage	V_{CC}	Applied across C1-E2 Terminals	0 ~ 800	Volts
	V_D	Applied between $V_{P1}-V_{PC}, V_{N1}-V_{NC}$	15 ± 1.5	Volts
Input ON Voltage	$V_{CIN(on)}$	Applied between	0 ~ 0.8	Volts
Input OFF Voltage	$V_{CIN(off)}$	$C_{P1}-V_{PC}, C_{N1}-V_{NC}$	$4.0 \sim V_{SXR}$	Volts
PWM Input Frequency	f_{PWM}	Using Application Circuit	5 ~ 20	kHz
Minimum Dead Time	t_{dead}	Input Signal	≥ 3.5	μs

PM200DSA120

FLAT-BASE TYPE
INSULATED PACKAGE

SATURATION VOLTAGE CHARACTERISTICS (TYPICAL)

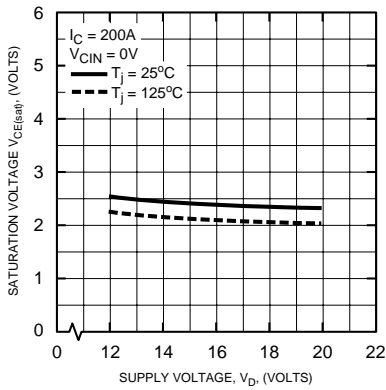

COLLECTOR-EMITTER SATURATION VOLTAGE CHARACTERISTICS (TYPICAL)

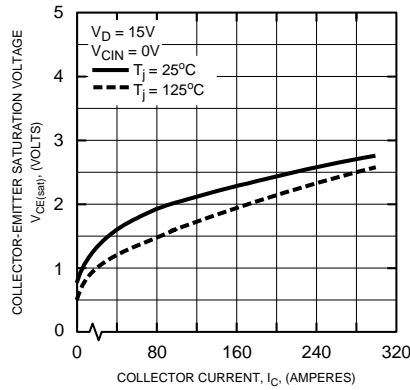

OUTPUT CHARACTERISTICS (TYPICAL)

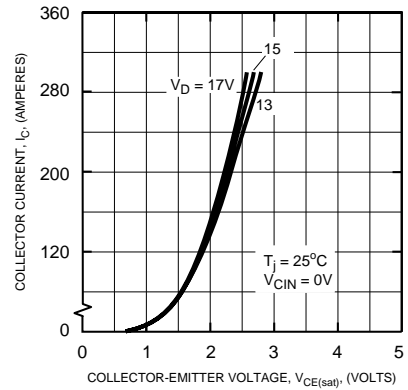

SWITCHING TIME VS. COLLECTOR CURRENT (TYPICAL)

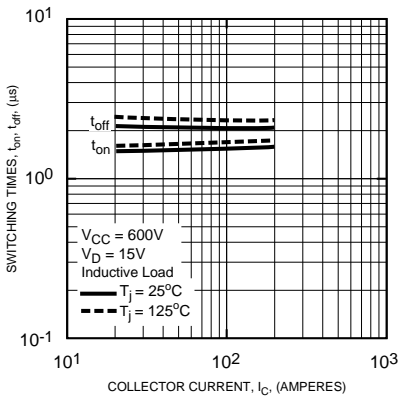

SWITCHING TIME VS. COLLECTOR CURRENT (TYPICAL)

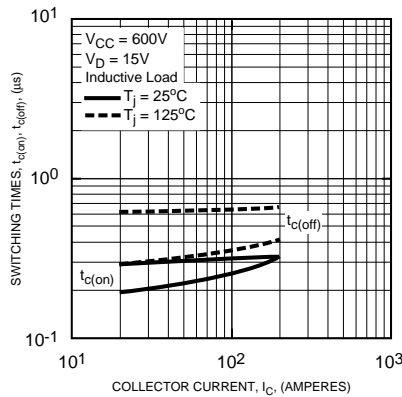

REVERSE RECOVERY CURRENT VS. COLLECTOR CURRENT (TYPICAL)

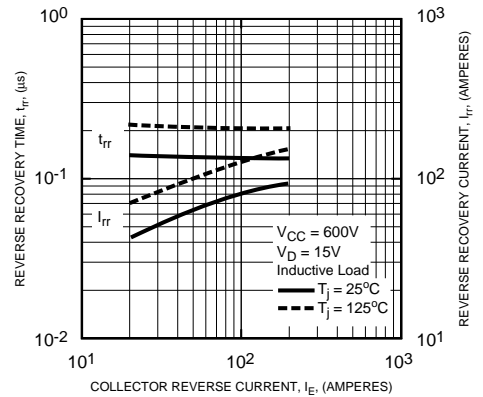

DIODE FORWARD CHARACTERISTICS

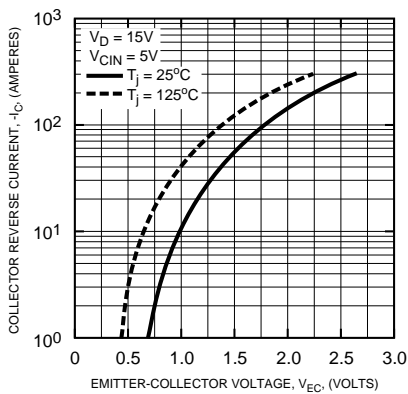

OVER CURRENT TRIP LEVEL VS. SUPPLY VOLTAGE (TYPICAL)

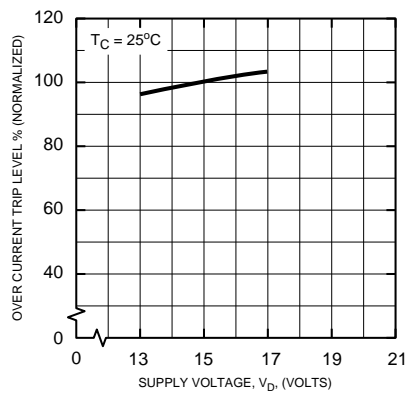

OVER CURRENT TRIP LEVEL VS. TEMPERATURE (TYPICAL)

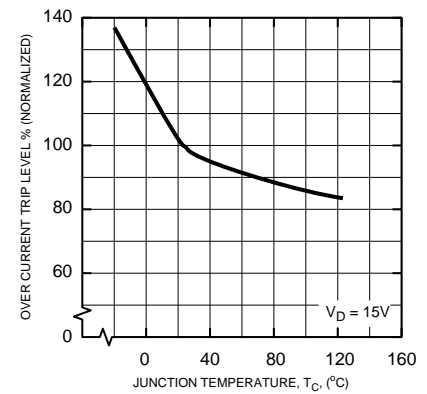

PM200DSA120

FLAT-BASE TYPE
INSULATED PACKAGE

FAULT OUTPUT PULSE WIDTH VS. TEMPERATURE (TYPICAL)

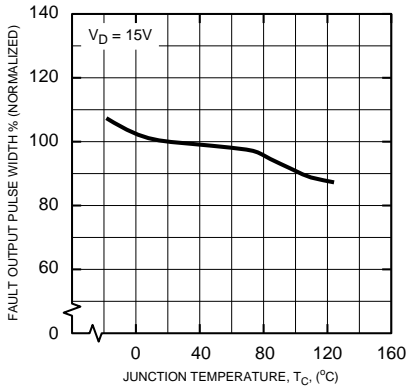

CONTROL SUPPLY VOLTAGE TRIP-RESET LEVEL TEMPERATURE DEPENDENCY (TYPICAL)

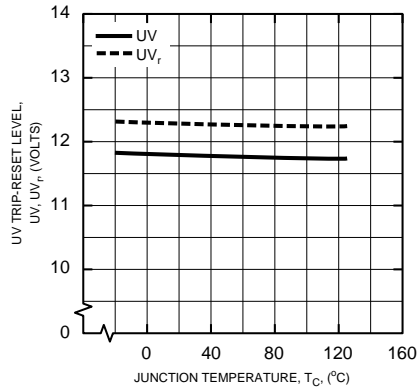

TRANSIENT THERMAL IMPEDANCE CHARACTERISTICS (Each IGBT)

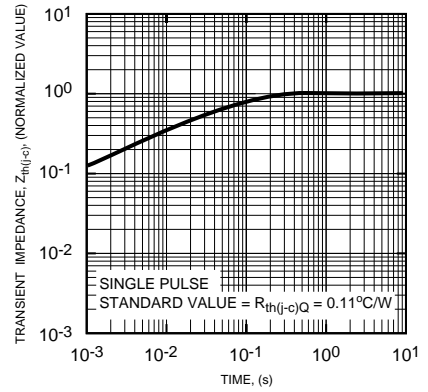

TRANSIENT THERMAL IMPEDANCE CHARACTERISTICS (Each FWDi)

